

Works well in 1st/2nd grade Options:
H goes first – fake or hand off
Z goes second – fake or hand off
B goes third – fake or hand off
Throw to X, Y, H, Z, or B
Can also fake to H and Z with pump fakes and delayed hand off to B

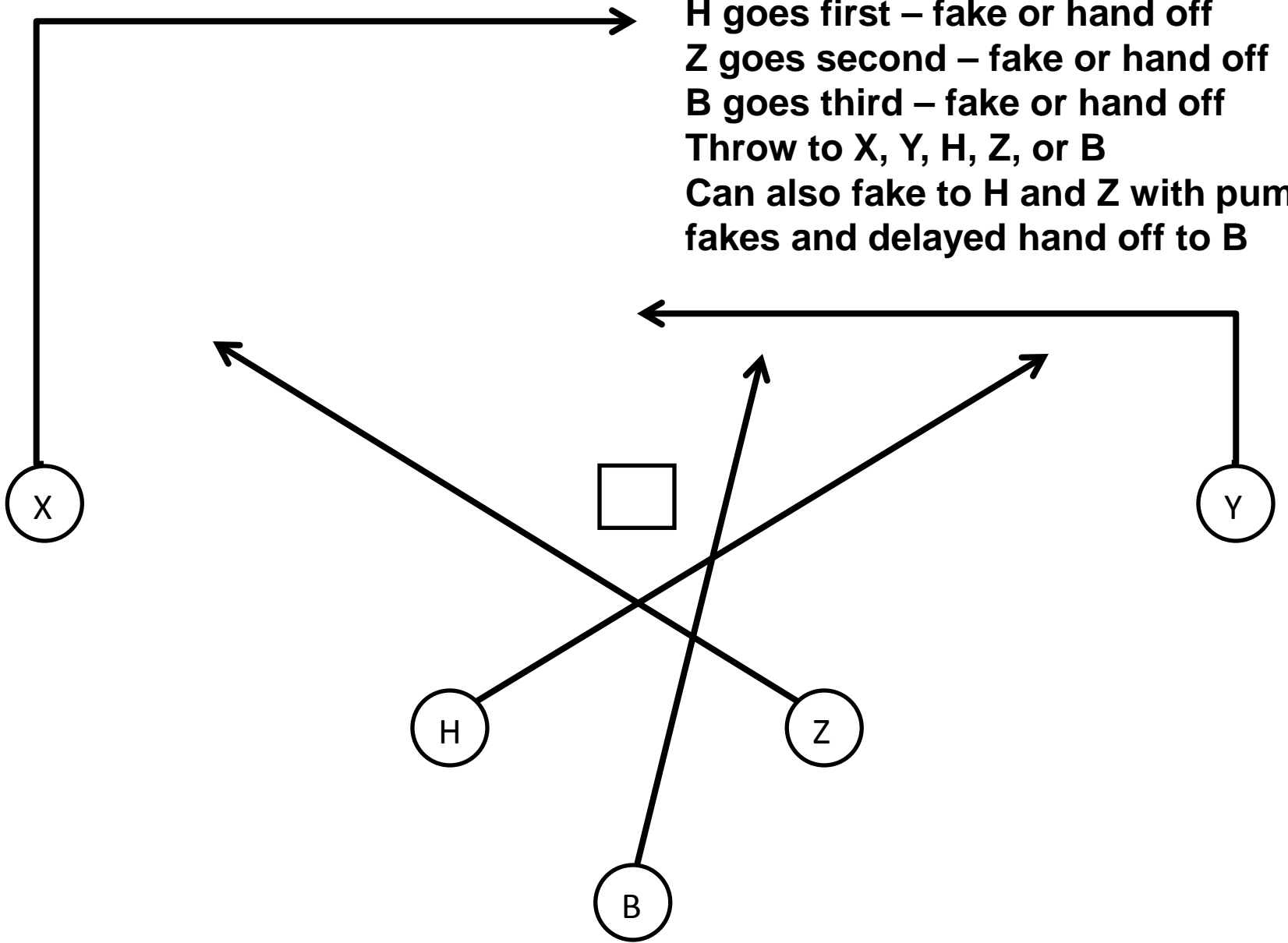

Same play other side
Works well in 1st/2nd grade options:
Z goes first – fake or hand off
H goes second – fake or hand off
B goes third – fake or hand off
Throw to X, Y, H, Z, or B
Can also jet sweep Y across

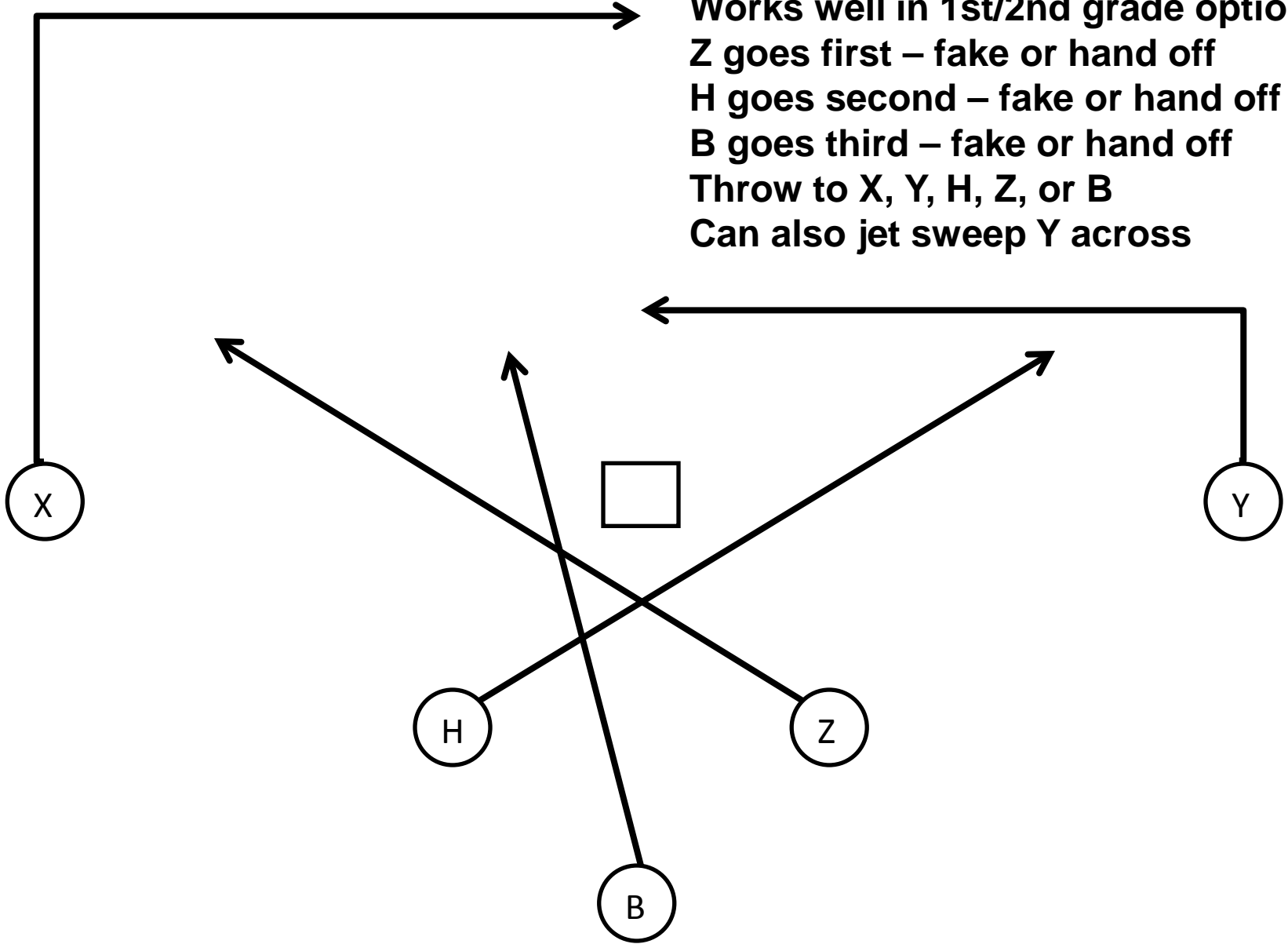

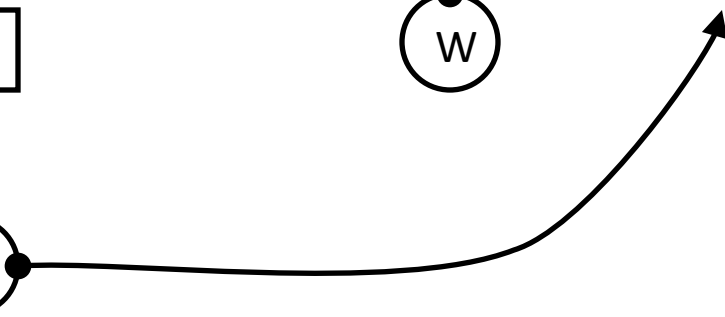
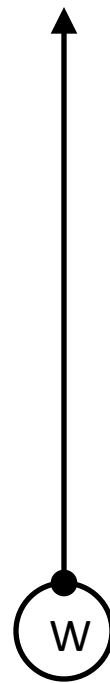
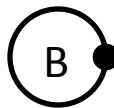

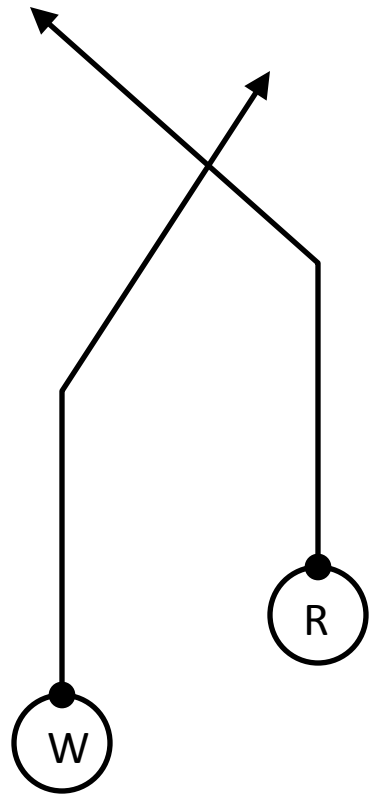
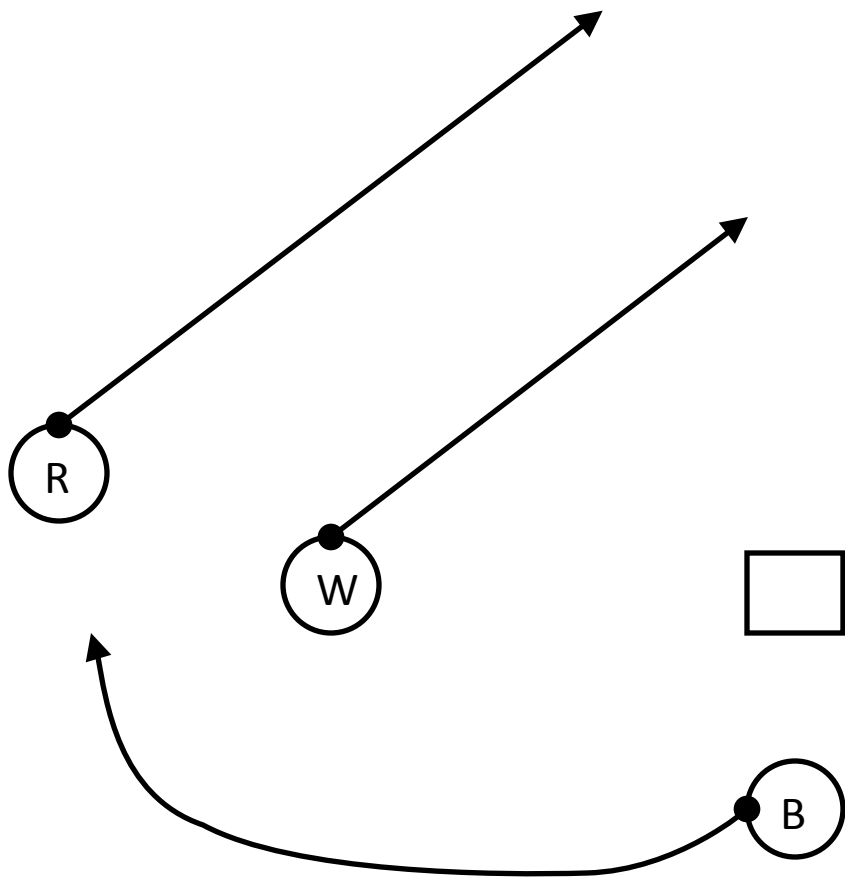

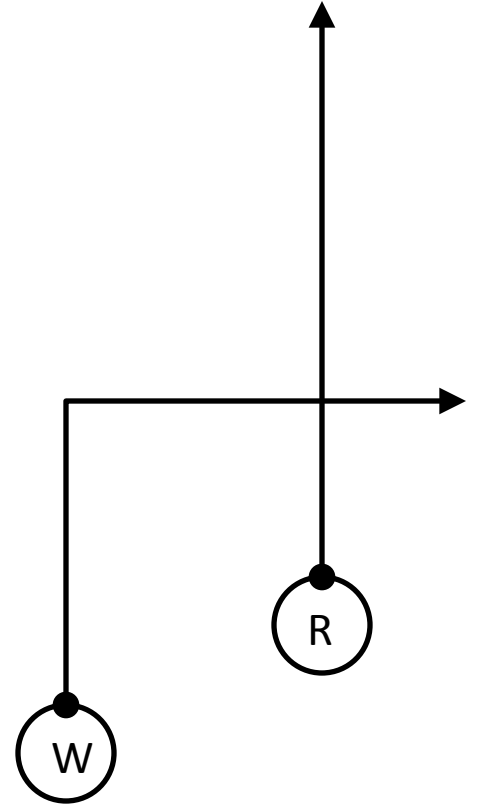
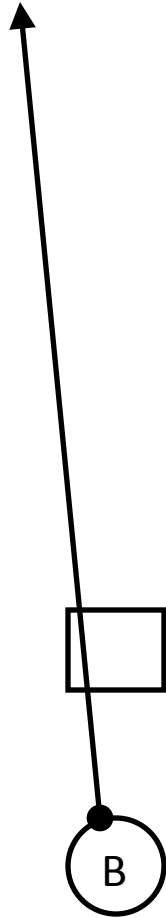
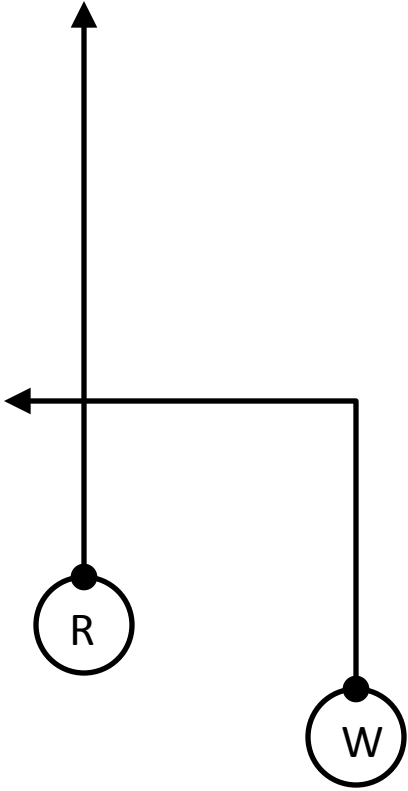

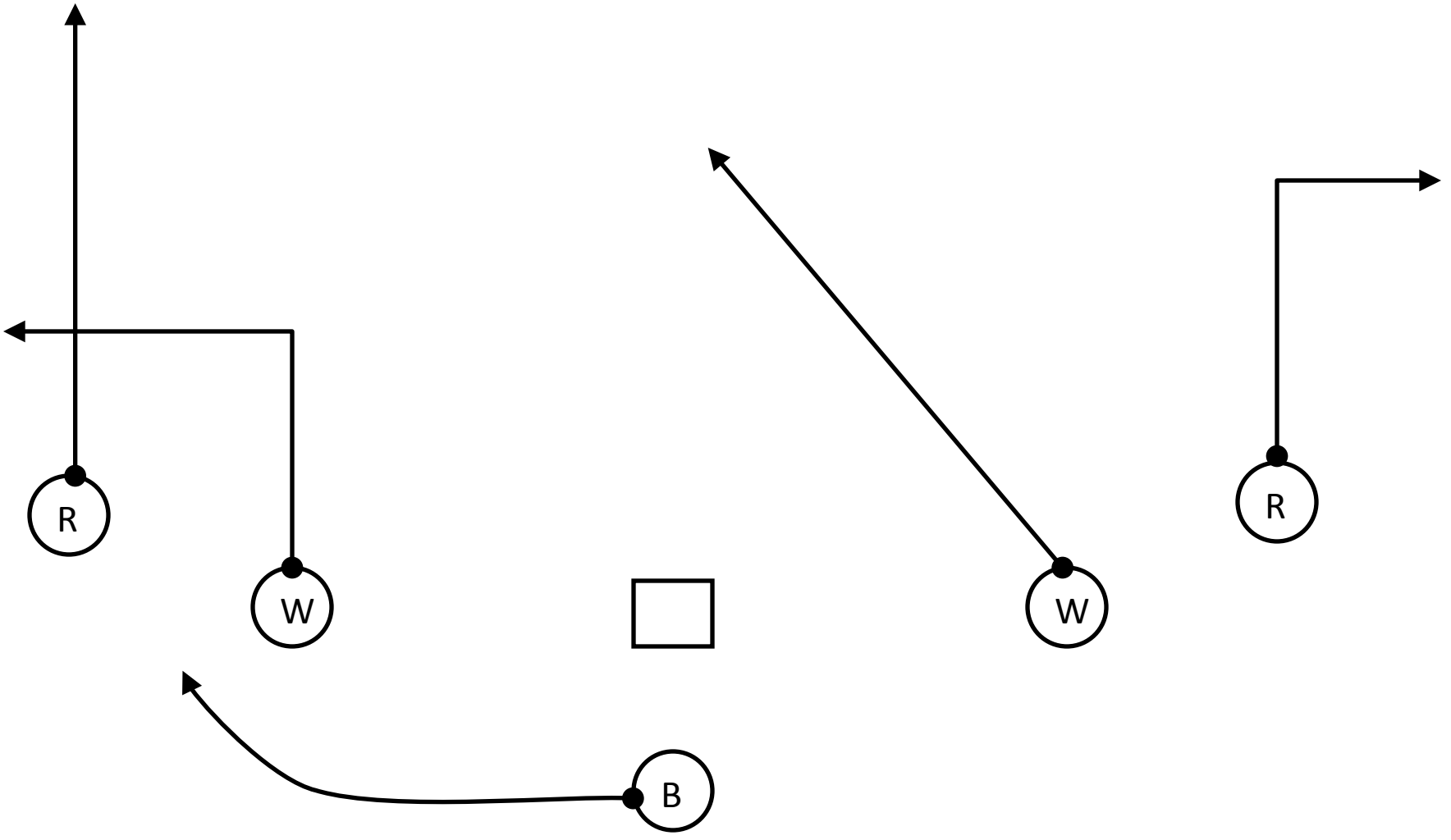

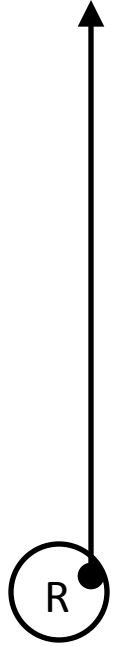
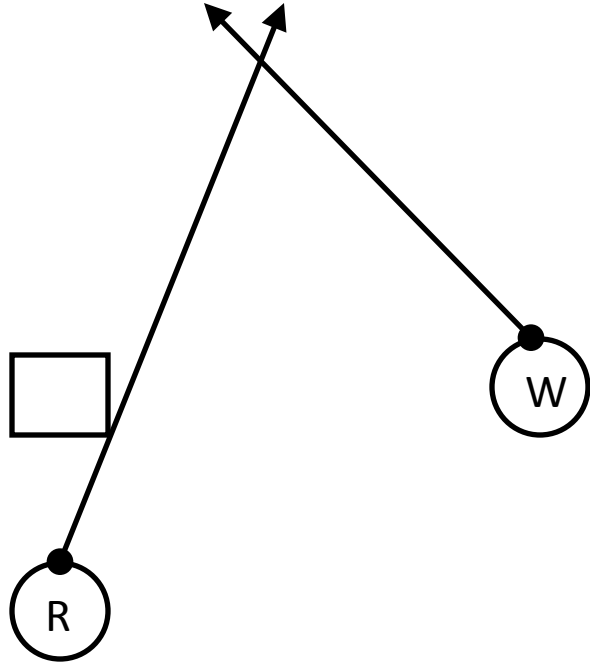
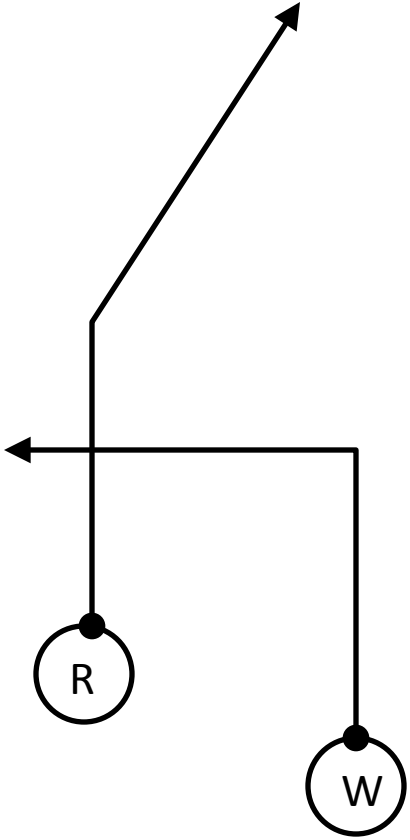

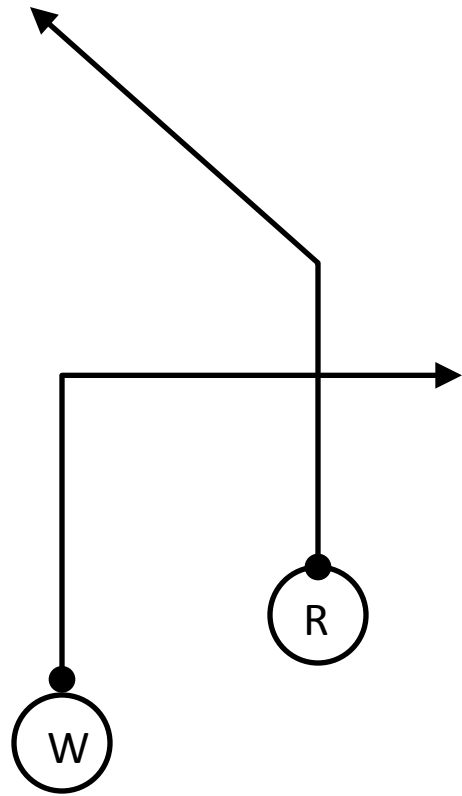
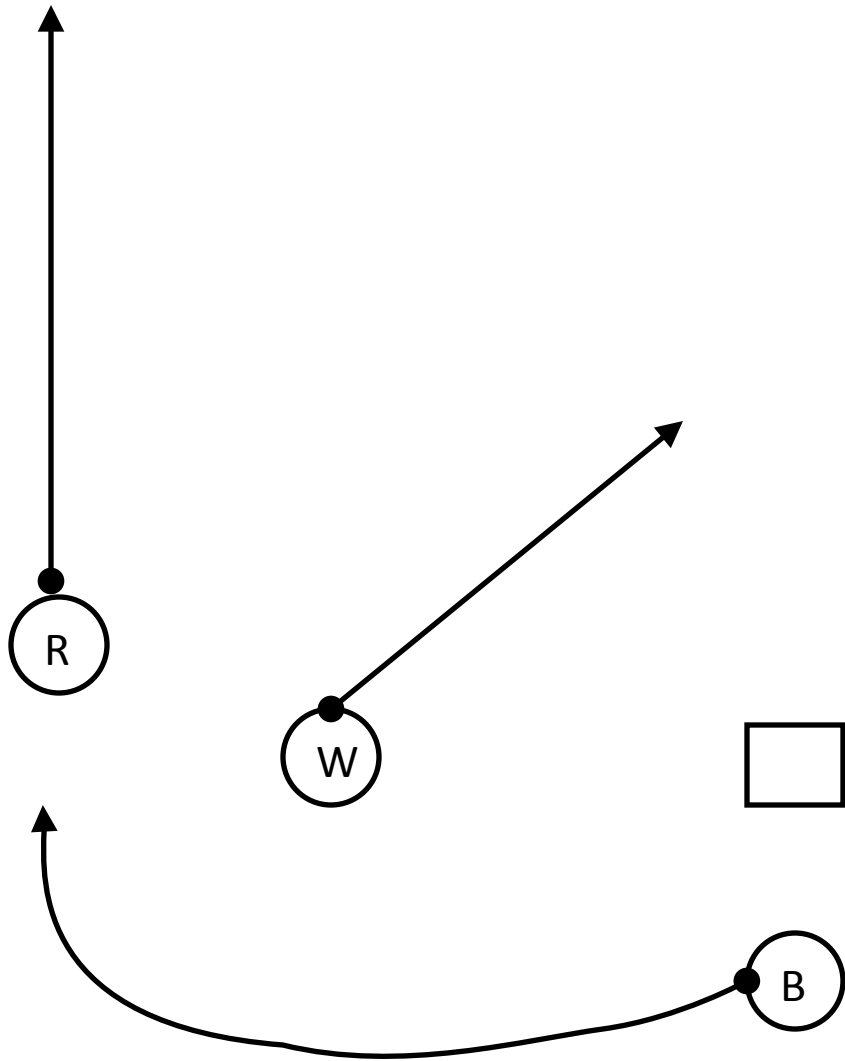

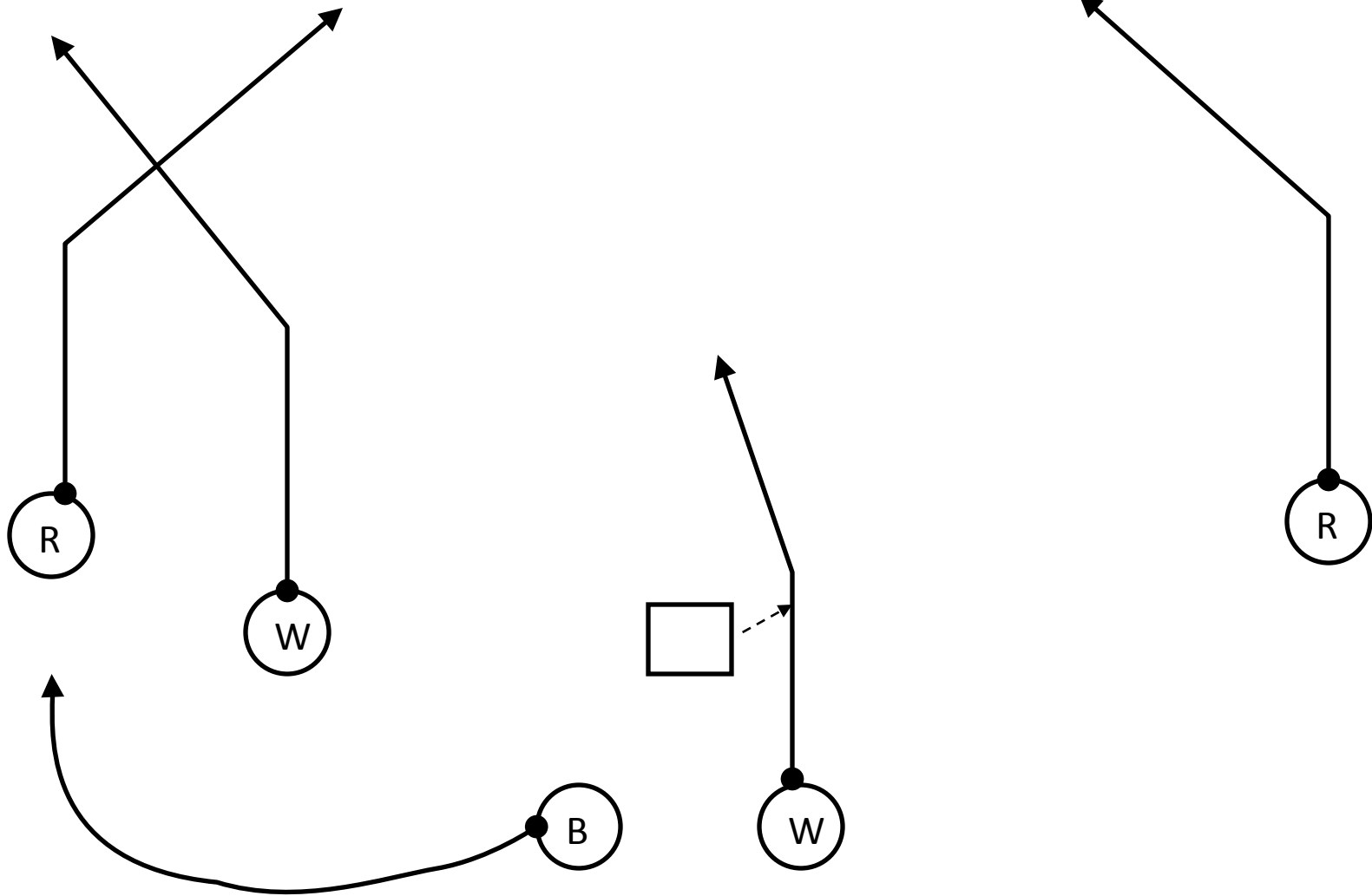

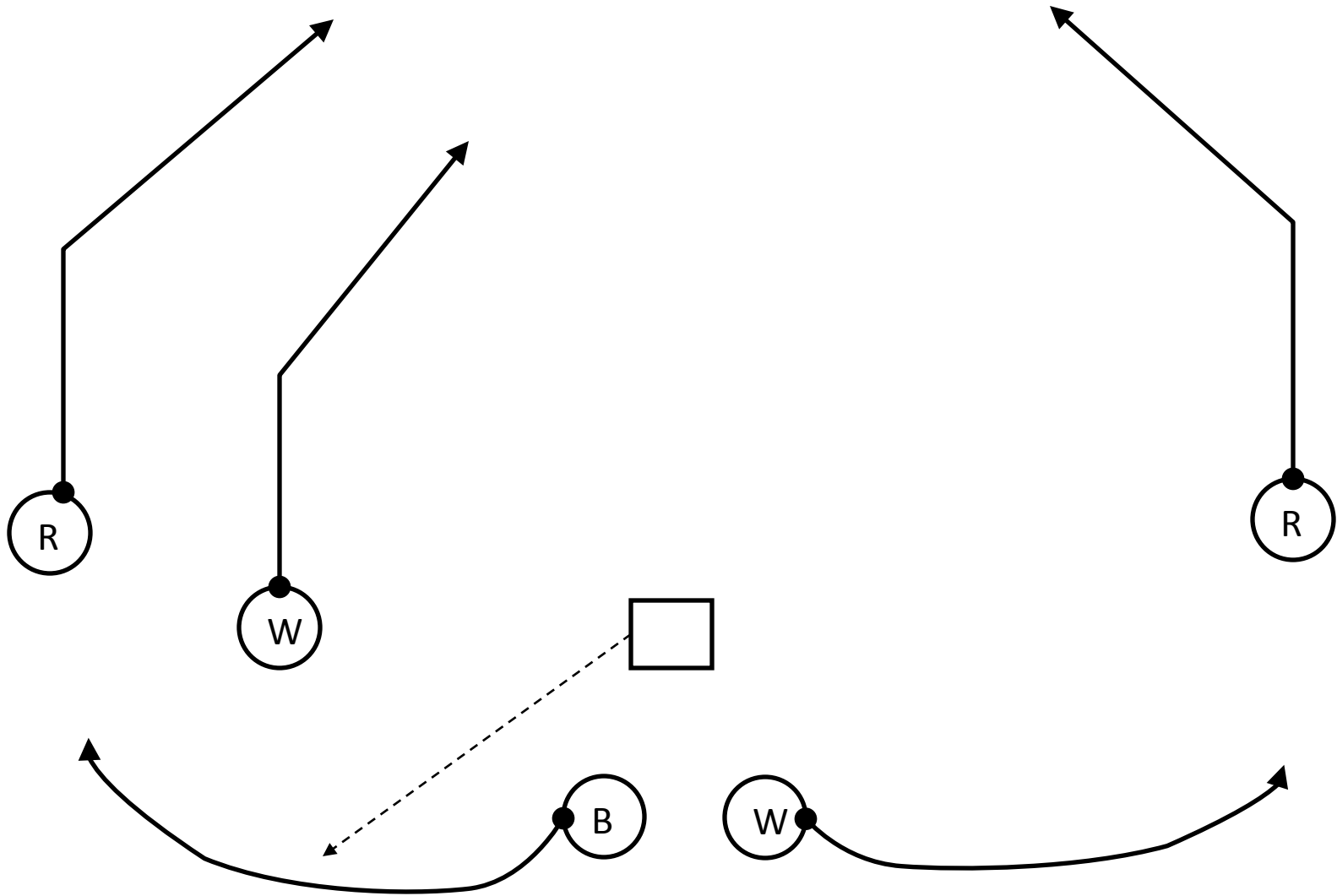

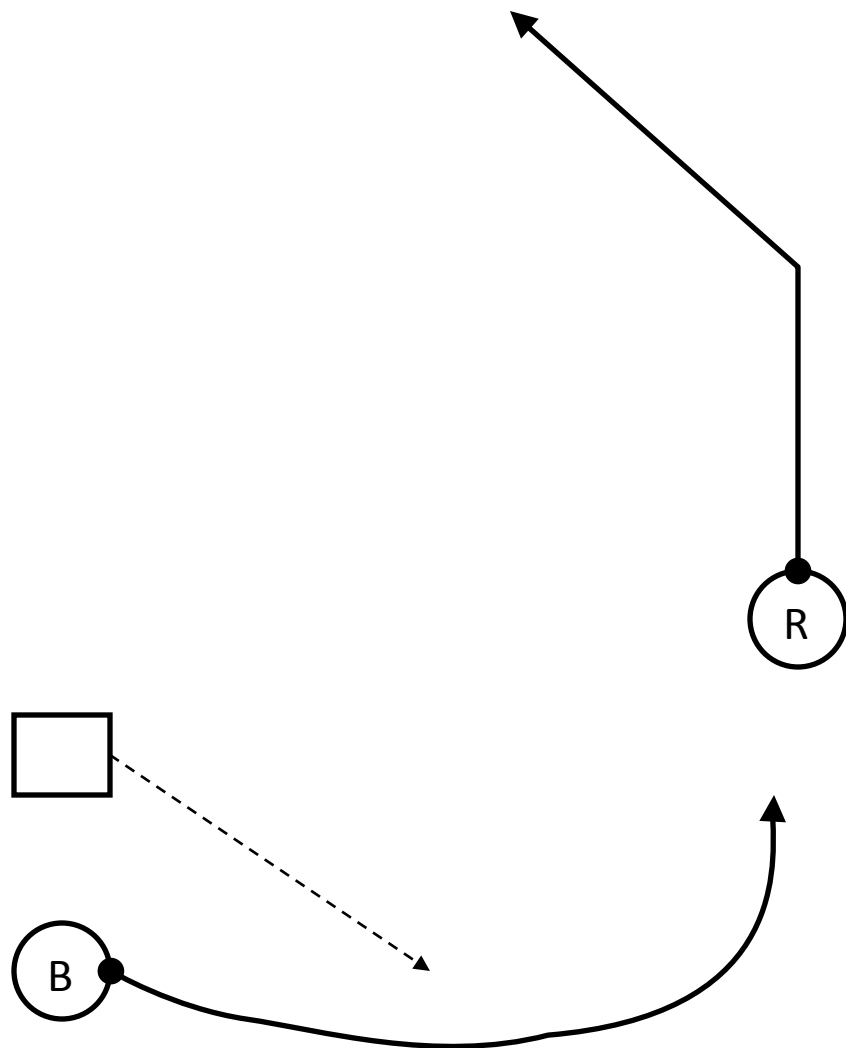
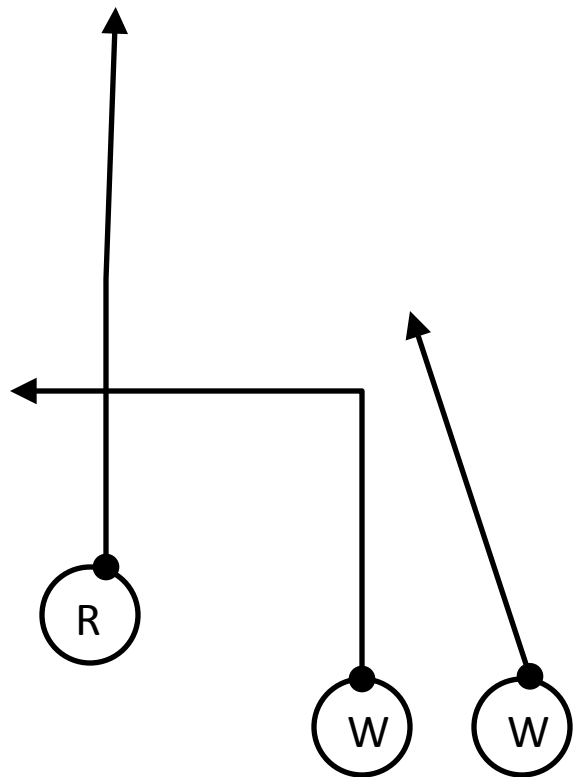

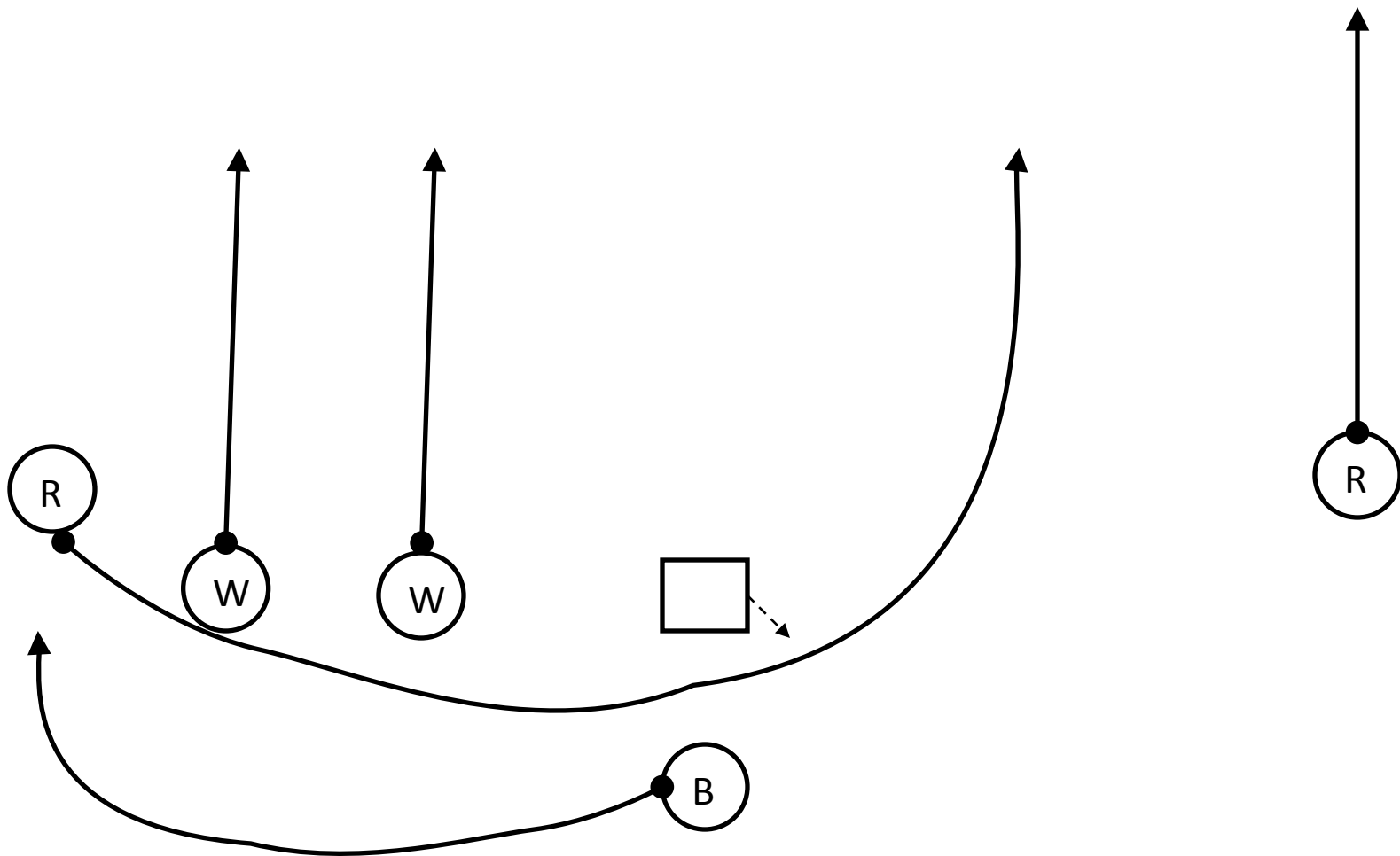

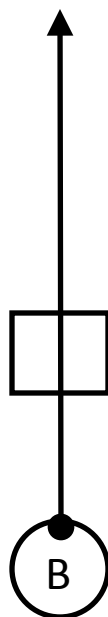
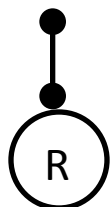

Ace - 1

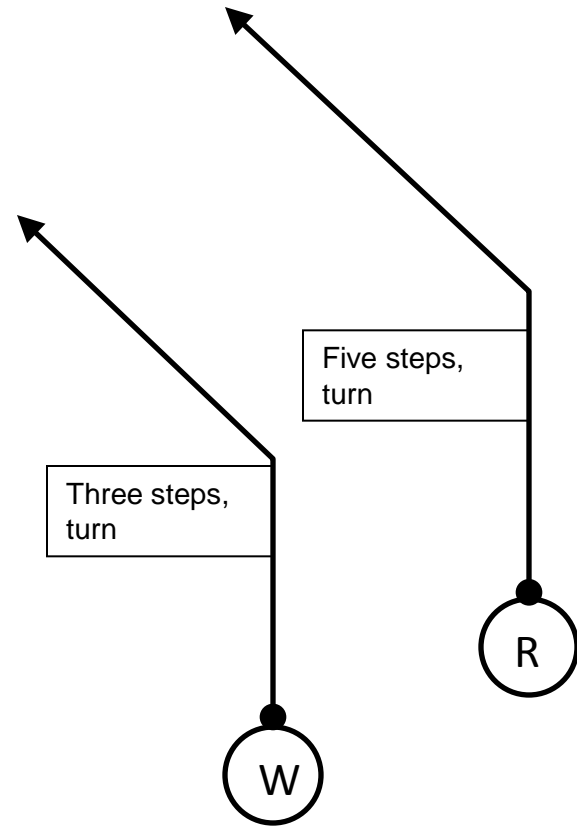
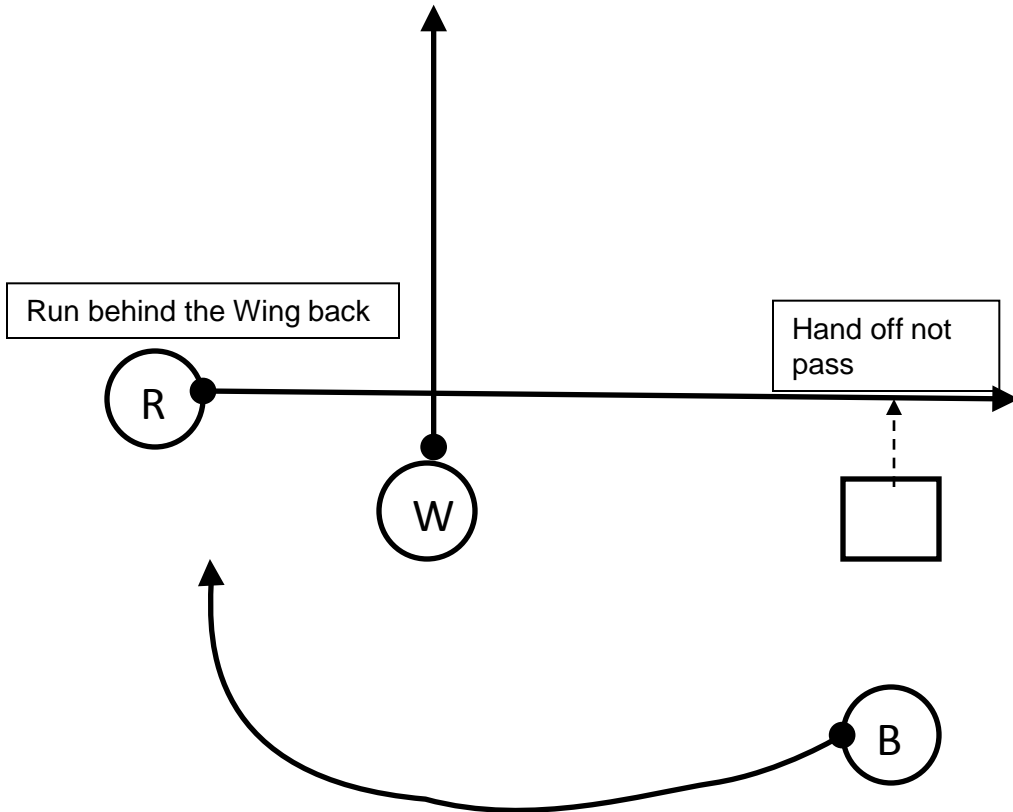

ACE - 2

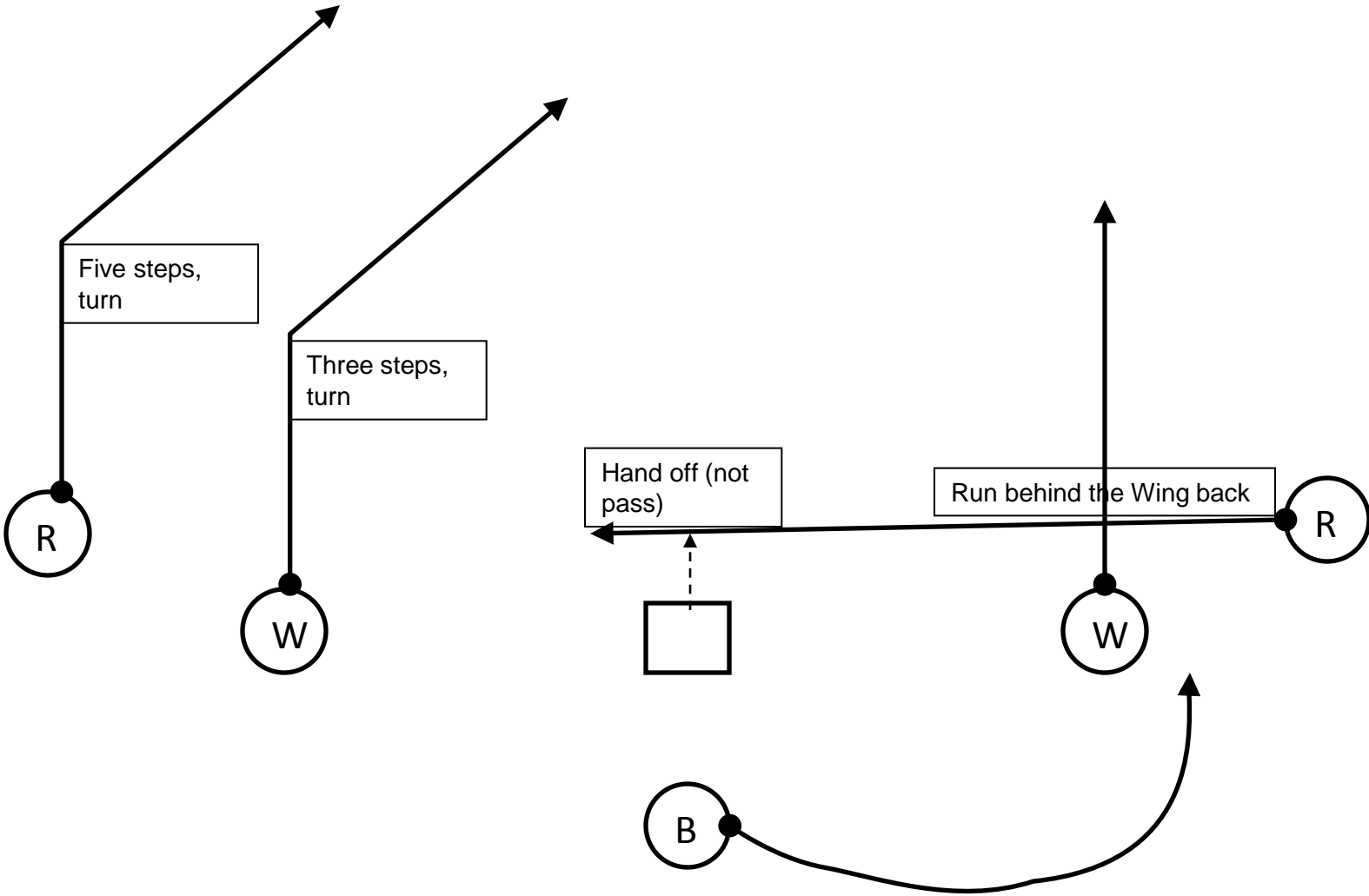

Trips Left

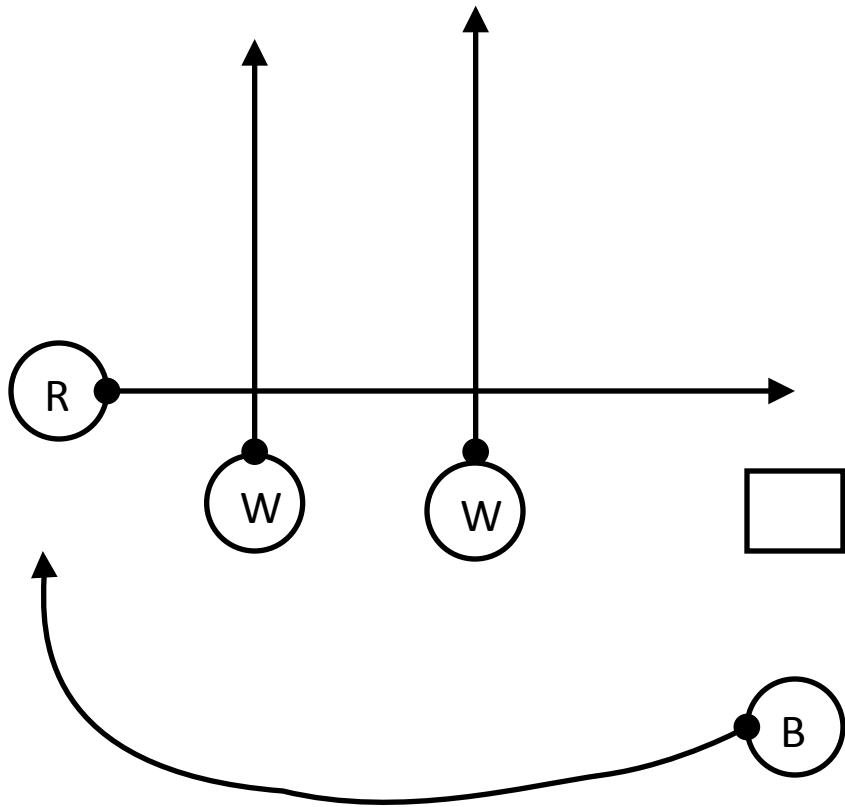

ACE - DOG

